

# AURATON

# 2025 RTH 2025

www.auraton.pl

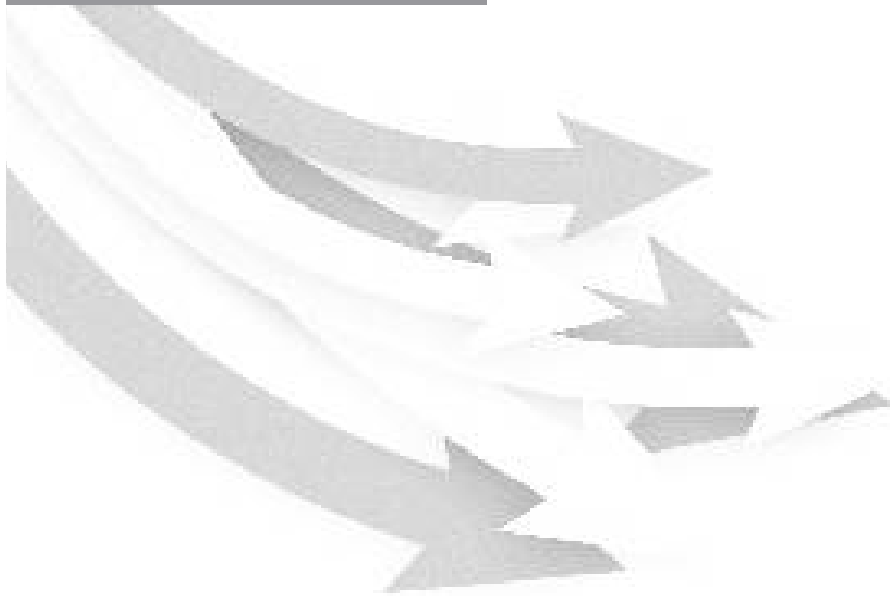

# User Manual

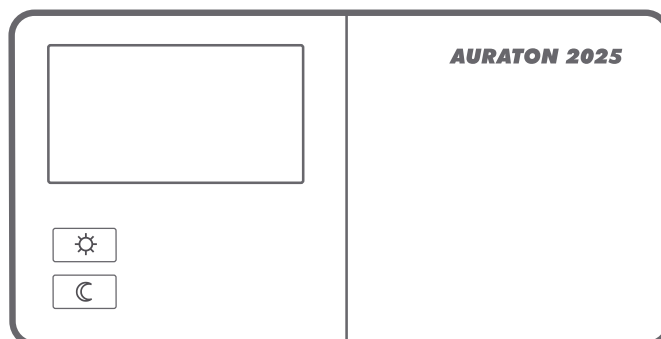
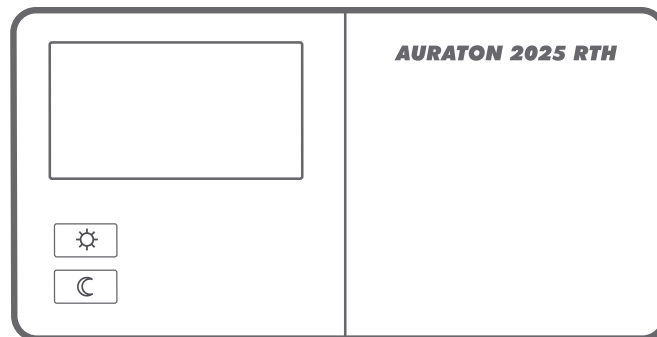
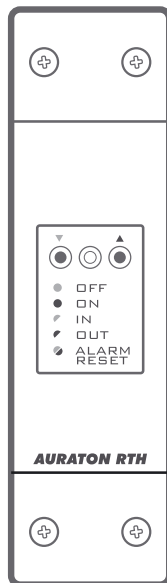

Thank you for purchasing this modern, advanced, microprocessor-based temperature regulator **AURATON 2025 / AURATON 2025 RTH**.



**4 independently settable temperatures:**

Day, night, anti-freeze, vacation.

**16A**

**Operation under the load of up to 16 A.**

The **AURATON RTH** receiver is equipped with a relay capable of operating with the load of up to 16 A. Its low-sparking technique of switching mains voltage contributes to the low wear of relay contacts.



**Interference-free communication between devices.**

The transmitter and the receiver from the **AURATON 2025 RTH** set communicate at the frequency of 868 MHz. Very short, encrypted data transmission packets (approx. 0.004 s) ensure very efficient and interference-free operation of the device.

**LCD**

**Backlit LCD display**

The backlit LCD display allows for supervising operation of the device even in a poorly lit room. (3 selectable backlight colours)

## Optional elements of the system

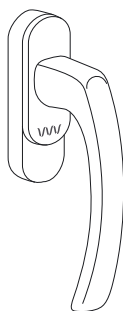

**AURATON H-1**

**Window handle** (sold separately)

A window handle, equipped with a position sensor and a transmitter, is an optional element of the system. This way the handle provides information about the state of the window. The handle also differentiates between 4 window positions: opened, closed, pivoted and trickle ventilated (micro-ventilation). The handle transmits information to the **RTH** receiver that controls the relay, e.g. switching off a heater in the event of opening the window or lowering the temperature down to 3 °C to conserve energy. One RTH receiver operates with max 25 handles.

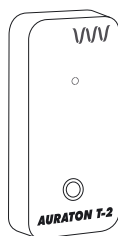

**AURATON T-2**

**Thermometer** (sold separately)

An optional element of the system allowing for controlling temperature in a room other than that with the **AURATON 2025 RTH** regulator.

## Description of the AURATON 2025 and 2025 RTH temperature regulator

On the right side of the front panel of the regulator you will find a sliding cover. There are buttons under the cover. You can easily remove the cover in order to replace batteries.

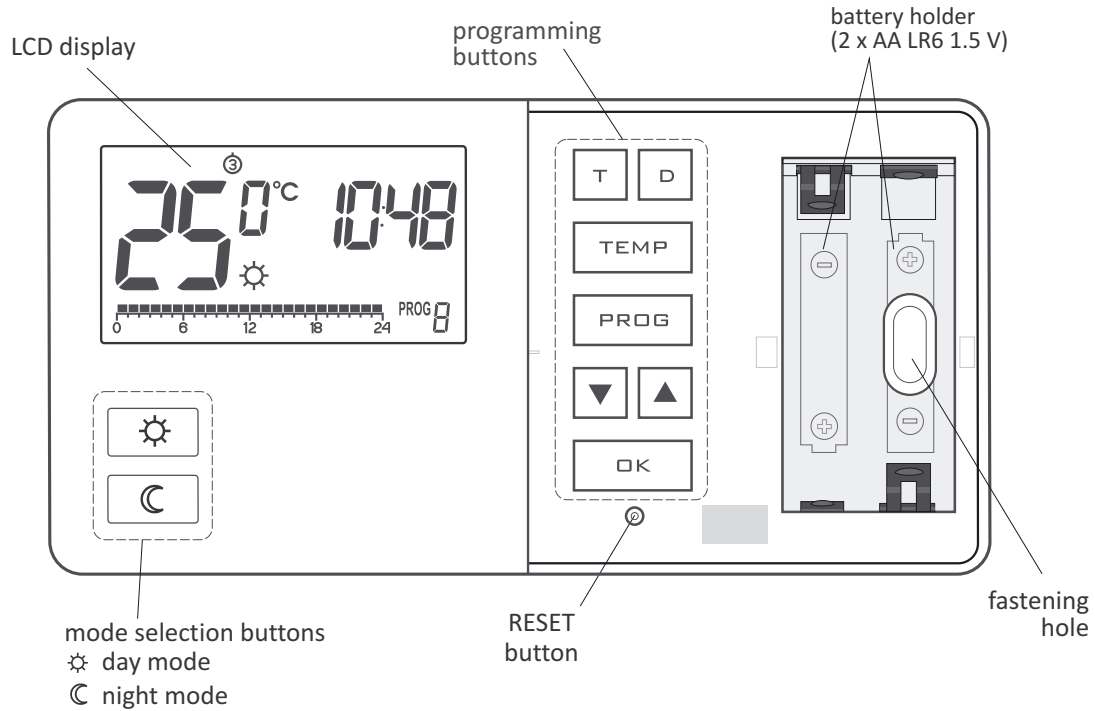

### Display

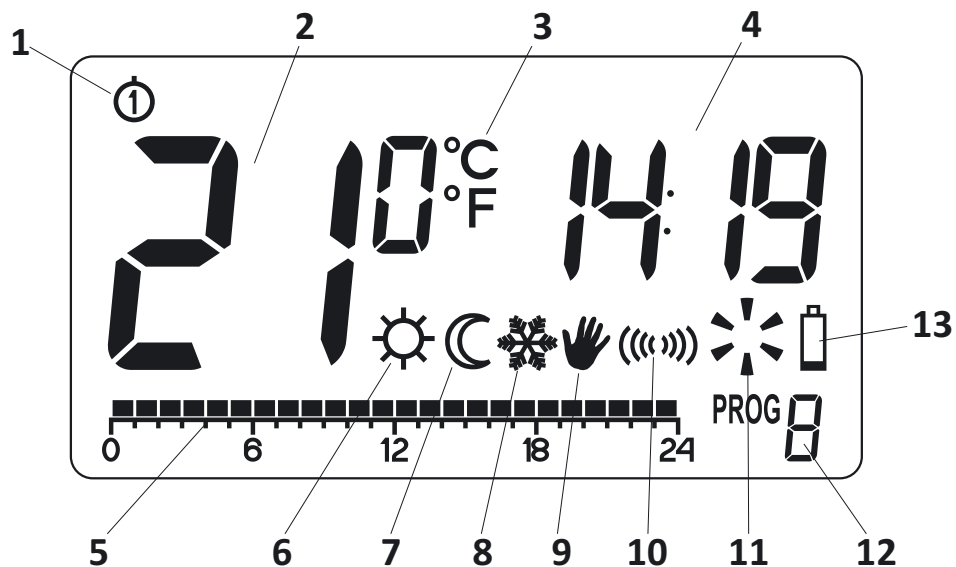

1. **Day of the week**  
Indicates the current day of the week. Every day is assigned a number.
2. **Temperature**  
In the normal mode of operation, the regulator displays the temperature in the room it is installed in.
3. **Temperature unit**  
Informs whether the temperature is displayed in degrees Celsius (°C) or in degrees Fahrenheit (°F).
4. **Clock**  
Time is displayed in the 24-hours format.
5. **Time line**  
A program progress indicator. It is a line divided into 24 sections. Each section corresponds to one hour. This line shows how a given program will be executed. (See chapter: "Time line")
6. **Day mode indicator (☀)**  
Indicates that at the moment, the regulator operates in day mode. (See chapter: "Temperature programming")
7. **Night mode indicator (☾)**  
Indicates that at the moment, the regulator operates in night mode. (See chapter: "Temperature programming")
8. **Anti-freeze mode indicator (❄)**  
Indicates that at the moment, the regulator operates in anti-freeze mode. (See chapters: "Temperature programming" and "Anti-freeze mode")
9. **Manual control indicator (✋)**  
Appears when you temporarily leave the mode of operation of the programmed mode (See chapters: "Manual control" and "Vacation mode")
10. **Transmission symbol (AURATON 2025 RTH)**  
Indicates ongoing communication with the **RTH** receiver.
11. **Regulator power-on symbol**  
Spinning fan informs about the state of operation of a controlled device and is visible only when the device is switched on (boiler, heater etc.).
12. **Program number**  
The number of the currently executed program is displayed. (See chapters: "Factory programs" and "Week-wise programming")
13. **Low battery (🔋)**  
This indicator will be visible when the battery voltage drops to the minimal allowable level. In such an event, replace the batteries as soon as possible.

**NOTE: In order to preserve the programmed parameters, the duration of the replacement operation must not to exceed 30 seconds.**

## Description of the AURATON RTH receiver

The **AURATON RTH** receiver cooperates with the **AURATON 2025 RTH** wireless receiver. The receiver is installed on the heating or air conditioning device and can operate under the load of 16 A.

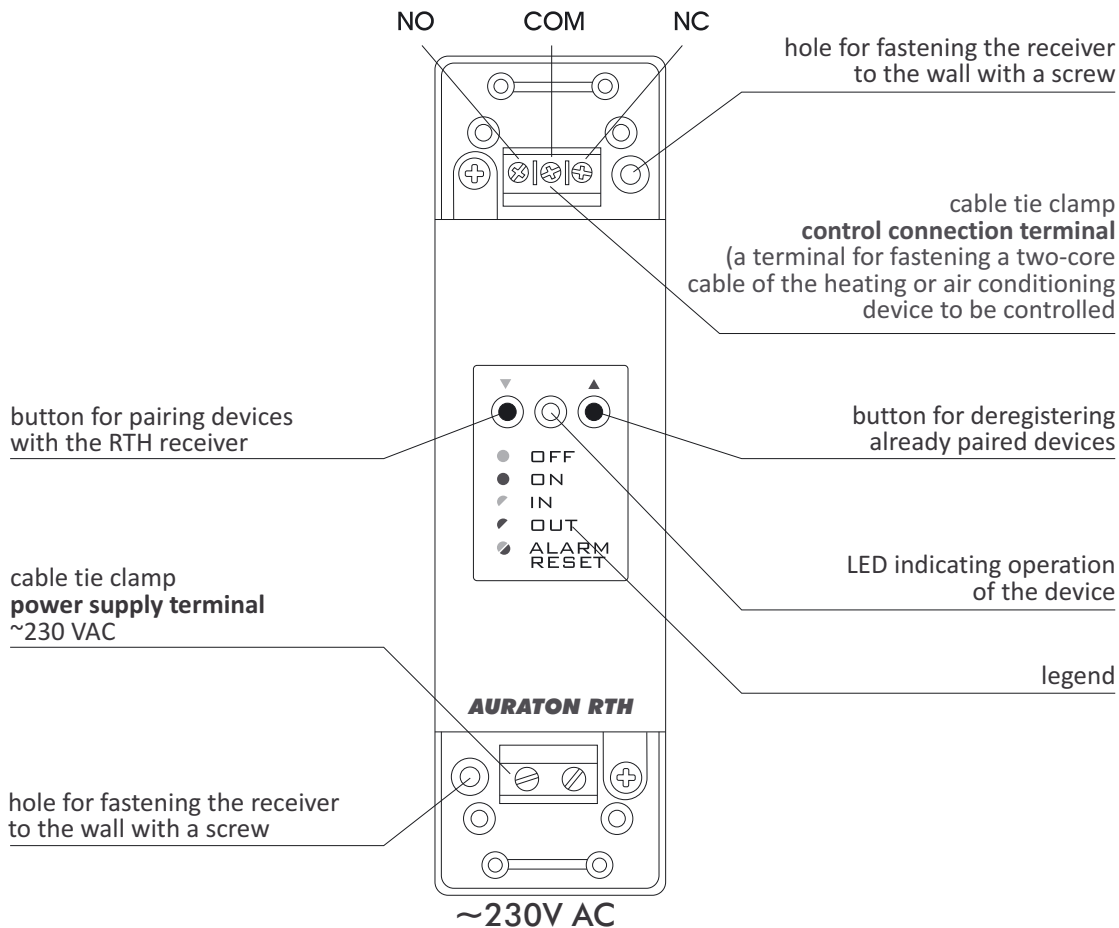

## Legend - description of LED signalling

- □ OFF    **The LED light's green** – the output device is off (*the contacts COM and NC are closed*).
- □ ON    **The LED light's red** – the output device is on (*the contacts COM and NO are closed*).
- ◐ IN    **The LED flashes green** – the **RTH** receiver awaits the device to be paired (*chapter: "Pairing the AURATON 2025 RTH wireless regulator and the RTH receiver"*).
- ◑ OUT    **The LED flashes red** – the **RTH** receiver awaits the device to be deregistered (*chapter: "Deregistering the regulator from the RTH receiver"*).
- ◐ ALARM RESET    **The LED flashes alternating red and green:**  
**ALARM** - the **RTH** receiver has lost connection with one of the paired devices (*chapter "Special situations"*).  
**RESET** - receiver deregisters all previously paired devices - (*chapter "Deregistering all devices paired with the RTH receiver"*).

## Selecting the proper location for the AURATON 2025 / 2025 RTH temperature regulator

Proper operation of the regulator is greatly affected by its location. Installing it in a place with no air circulation or exposed to direct sunlight causes improper regulation of temperature. In order to ensure proper operation, the regulator must be installed on an interior wall of a building (partition wall). A place should be selected that is occupied most frequently, providing undisturbed circulation of air. Avoid heat radiating devices (television set, heater, refrigerator etc.) or places exposed to direct sunlight. In order to avoid vibration, do not place the regulator in close vicinity of doors.

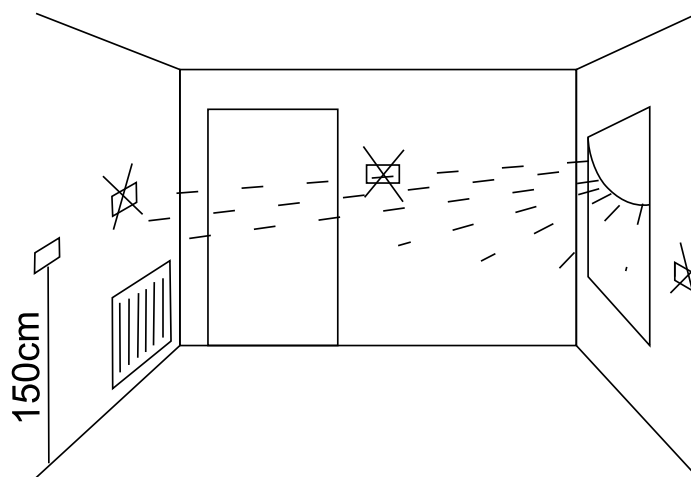

## Connecting cables to AURATON 2025

Cable terminals are located on the rear wall of the regulator. This is a typical Single Pole Double Throw relay. In the majority of applications the NC terminal is unused.

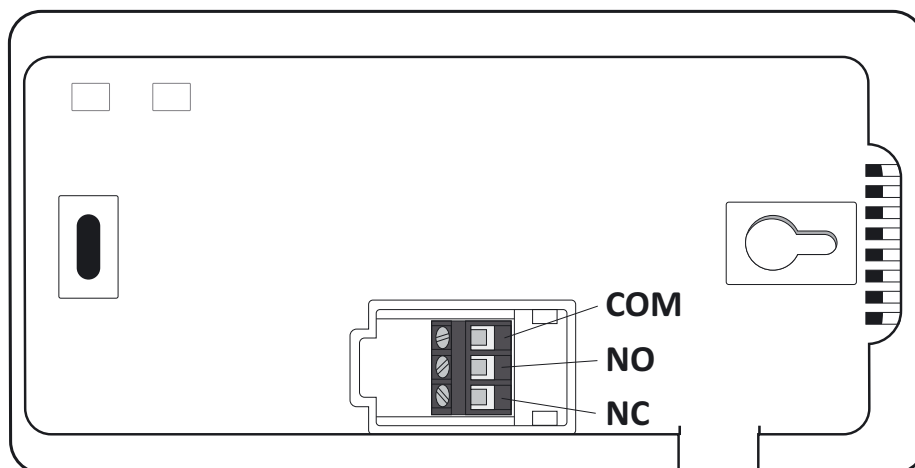

## Fastening the temperature regulator to the wall

1. Drill two holes 6 mm in diameter in the wall (use the template attached to the manual to mark the spacing between these holes).
2. Insert plastic wall plugs (included in the kit).
3. Screw in the left screw with a 3 mm clearance.
4. Put the regulator over the screw head and slide it to the left (pay attention to the key-hole in the rear wall of the regulator).

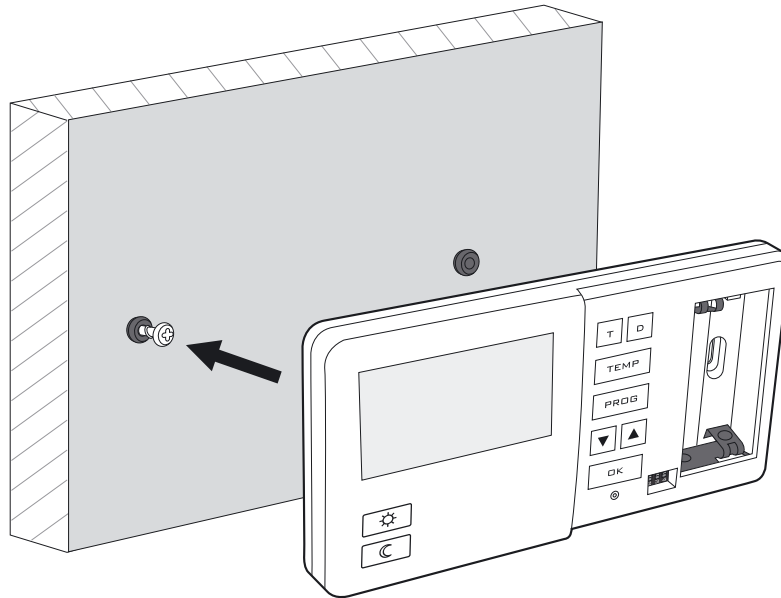

5. Screw in the right screw, making sure it holds the regulator securely.

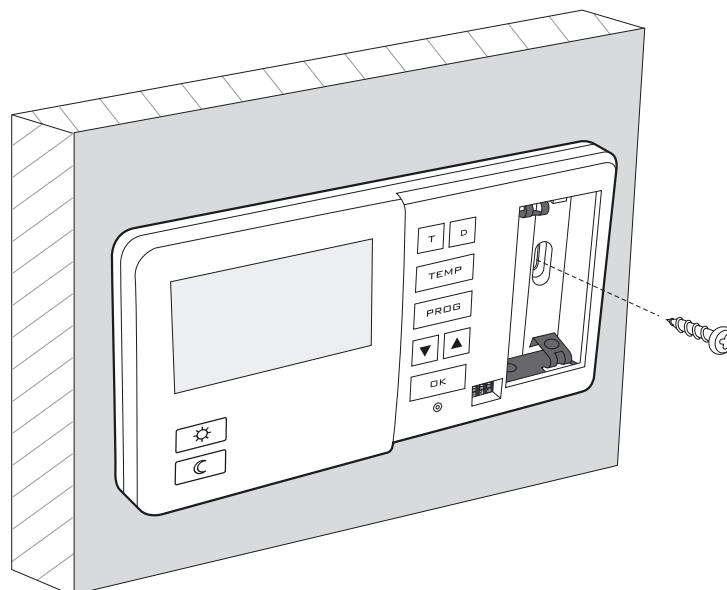

**NOTE:** If the wall is wooden, there is no need to use wall plugs. In such a case, drill two holes 2.7 mm in diameter instead of 6 mm, and screw the screws directly into the wood.

## Fastening the RTH receiver

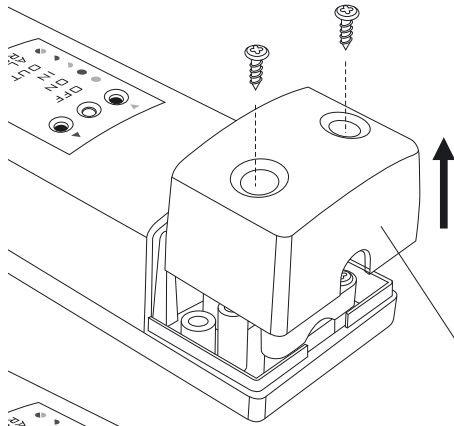

**NOTE:** When installing the **AURATON RTH** receiver its power supply must be disconnected. It is recommended that the installation is performed by a qualified specialist.

1. Take off protective covers from the lower and upper part of the **AURATON RTH** receiver.

protective cover

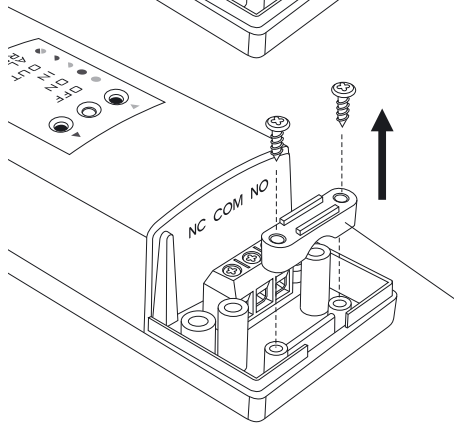

2. Take off cable tie clamps from the lower and upper part of the **AURATON RTH** receiver.

cable tie clamp

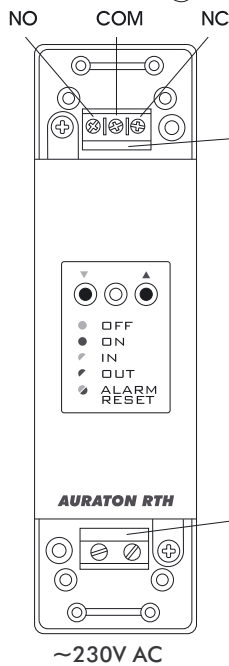

3. Connect the heating device to the **control connection terminals** of the **AURATON RTH** receiver. Proceed in accordance with the service manual of the heating device. Most commonly, the **COM** (common) and **NO** (normally open) terminals.

4. Connect power supply conductors to the **power supply terminals** of the **AURATON RTH** receiver, observing safety rules.

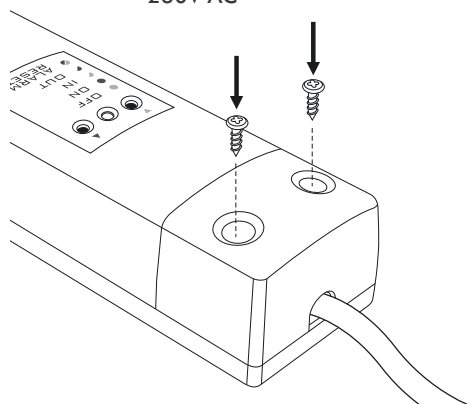

5. After connecting the conductors, they must be secured with the cable tie clamps and reinstall protective covers of the **AURATON RTH** receiver.

**NOTE:**

The permanent electrical system of a building must include a breaker and an overcurrent protection.





## Fastening the RTH receiver to the wall

To fasten the **AURATON RTH** receiver to the wall:

- 1) Remove protective covers from the lower and upper part of the regulator.  
(See chapter: "Fastening the RTH receiver").
- 2) On the wall, mark the location of holes for fastening screws.
- 3) In marked places, drill holes of a diameter corresponding to the bundled wall plugs (5 mm).
- 4) Insert wall plugs into the drilled holes.
- 5) Screw in the RTH receiver to the wall with screws, making sure they hold the receiver securely.

hole for fastening  
the receiver to the wall with a screw

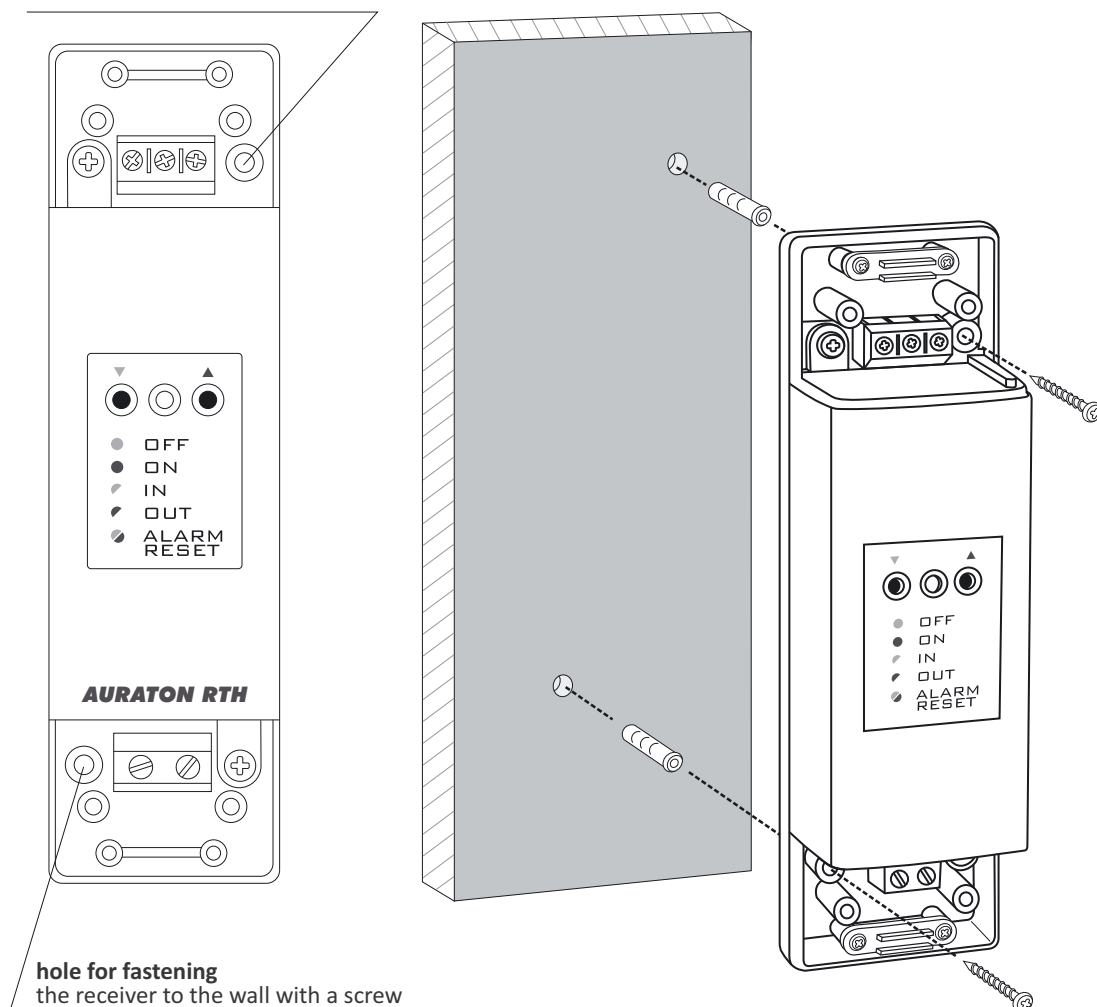

**NOTE:** If the wall is wooden, there is no need to use wall plugs. In such a case, drill two holes 2.7 mm in diameter instead of 5 mm, and screw the screws directly into the wood.

**NOTE:** The **RTH** receiver cannot be placed in metal containers (e.g. an assembly box, a metal enclosure of a heater) in order to not to interfere with its operation.

## Pairing the AURATON 2025 RTH wireless temperature regulator with the RTH receiver

**NOTE:** The **AURATON 2025 RTH** wireless temperature regulator sold with the **AURATON RTH** receiver is already paired. **Devices sold separately require “pairing”.**

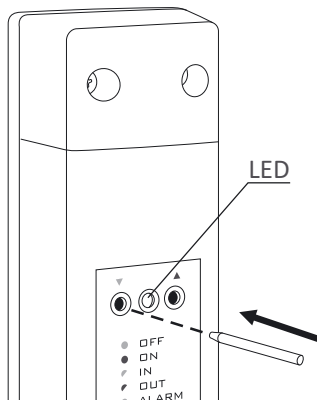

1. The process of pairing the **2025 RTH** regulator with the **RTH** receiver is initiated by pressing the left pairing button (marked with a green triangle - ▼ ) on the **RTH** receiver and holding it for at least 2 seconds, until the LED starts flashing green, and then releasing the button.

*The **AURATON RTH** receiver waits for pairing for 120 seconds. After that time, it automatically returns back to normal operation.*

2. On the **AURATON 2025 RTH** regulator, press the **PROG** button and hold it for 5 seconds until the transmission symbol (Ⓜ) appears on the display. Release the button - the regulator transmits the pairing signal for 5 seconds.
3. A properly completed pairing process is signalled by the LED on the **AURATON RTH** receiver no longer flashing green and the receiver reverting back to normal operation.

*In the event of an error during the pairing process, repeat steps 1 and 2. Should more errors occur, deregister all devices by executing the **RESET** function of the **RTH** receiver (see “**RESET - Deregistering all devices paired with the RTH receiver**”) and attempt to pair the device again.*

**NOTE:** One receiver can have only one temperature regulator assigned.

## Deregistering the regulator from the RTH receiver

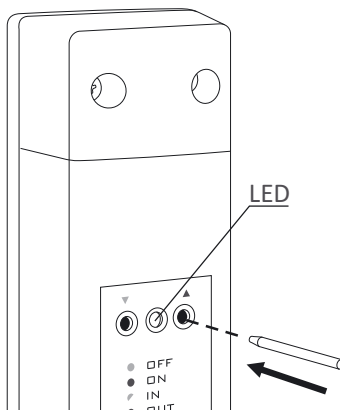

1. Deregistering the **2025 RTH** regulator from the **RTH** receiver is initiated by pressing the right deregistering button (marked with a red triangle - ▲ ) on the **RTH** receiver and holding it for at least 2 seconds, until the LED starts flashing red, and then releasing the button.

*The **AURATON RTH** receiver waits for deregistering for 120 seconds. After that time, it automatically returns back to normal operation.*

2. On the **AURATON 2025 RTH** regulator, press the **PROG** button and hold it for 5 seconds until the transmission symbol (  ) appears on the display. Release the button - the regulator transmits the pairing signal for 5 seconds.
3. A properly completed deregistering process is signalled by the LED on the **AURATON RTH** receiver no longer flashing red and the receiver reverting back to normal operation.

In the event of an error during the deregistering process, repeat steps 1 and 2. Should more errors occur, deregister all paired devices (see “RESET - Deregistering all devices paired with the RTH receiver”) and attempt to pair the device again.

## RESET - Deregistering all devices paired with the RTH receiver

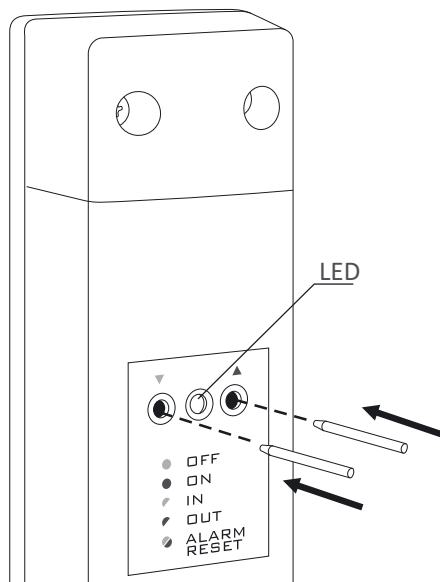

In order to deregister all devices paired with the RTH receiver, simultaneously press both the pairing and the deregistering button ( ▼ and ▲ ) and hold them for at least 5 seconds until the LED flashes alternating red and green. Then release both buttons.

A properly completed process of deregistering all devices is signalled after approx. 2 seconds by the LED colour changing to green and then switching it off for a short period of time.

**NOTE:** If after executing the RESET function the RTH receiver is disconnected from power supply and then connected again, the receiver will automatically enter “pairing” mode for 120 seconds. A newly purchased RTH receiver without any factory-paired devices (i.e. not the one bundled with the regulator) will behave the same way.

## Signalling operation and reception of data packet



Each radio transmission received by the **AURATON RTH** receiver from the paired device is signalled by a temporary change of LED colour to orange. Switching on the relay is signalled by the LED lit red, whereas switching it off is signalled by the LED lit green.

## Starting-up the regulator for the first time

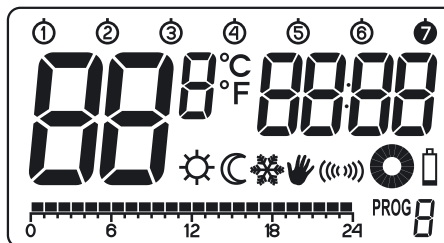

After the proper placement of batteries in the battery holder, all segments of the LCD display are displayed (display test) for one second; during the next second, the software version number is displayed.





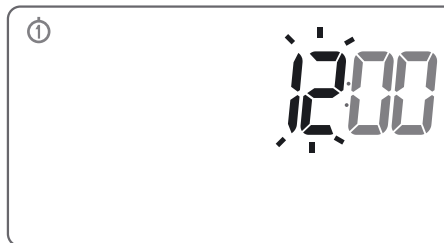

Following that, the regulator enters time setting mode; the hour field flashes, prompting for setting it.

Using the  and  buttons, set the desired hour value and confirm the setting with the  button.

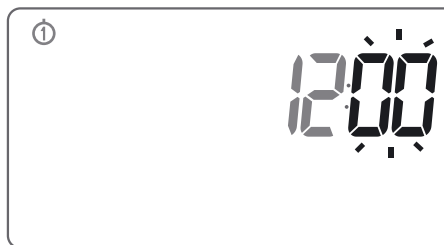

The regulator switches to setting minutes. Using the  and  buttons, set the desired minute value and confirm the setting with the  button.



In the upper part of the display, the day of the week symbol starts flashing. Using the  and  buttons, set the desired day of the week and confirm the setting with the  button.

The regulator enters its normal mode of operation.

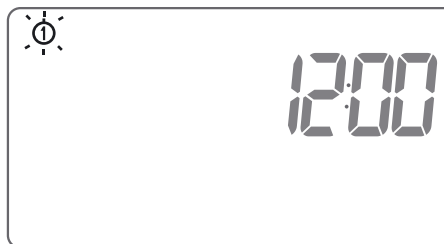

### NOTE:

- 1) If no button is pressed in 60 seconds when setting the hour value for the first time, the regulator will automatically enter its normal mode of operation.
- 2) When programming any other functions, failing to press any buttons in 10 seconds is equivalent to pressing the  button.

## Setting the clock

In order to set the clock:

1. Press the **T** button. The hour field starts flashing, prompting for setting it.
2. Using the **▼** and **▲** buttons, set the desired hour value.
3. Then press the **T** button again. The minute field starts flashing, prompting for setting it.
4. Using the **▼** and **▲** buttons, set the desired minute value.
5. Confirm the setting with the **OK** button.

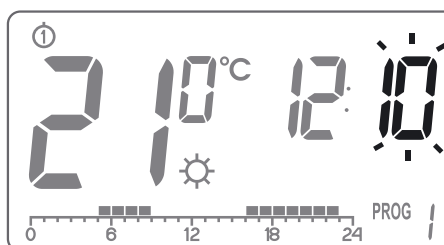
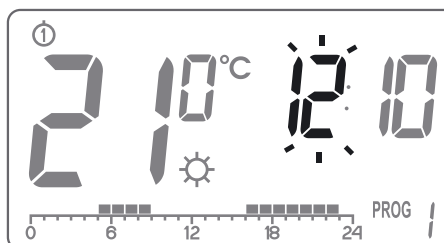

## Setting the day of week ① ... ⑦

In order to set the day of week:

1. Press the **D** button. One of the digits representing days of the week starts flashing, prompting for setting it.
2. Using the **▼** and **▲** buttons, set the desired day of week.
3. Confirm the setting with the **OK** button.

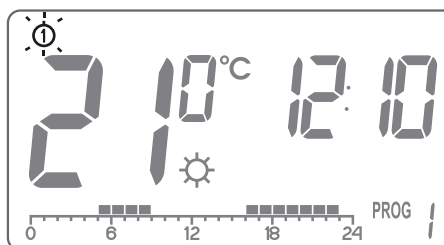

## LO, HI indicator

- If measured temperature is lower than 5°C LCD will display "LO".
- If measured temperature is higher than 30°C LCD will display "HI".



## Default settings of programs

- **Monday – Friday:**

The heating device maintains day temperature from 05:00 to 08:00 and from 15:00 to 23:00.

- **Saturday – Sunday**

The heating device maintains day temperature from 06:00 to 23:00.

- **Default temperature setpoints:**

- ☀ Day temperature – 21,0 °C
- ☾ Night temperature – 19,0 °C
- ❄ Anti-freeze temperature – 7,0 °C

## Programming the day ( ☀ ), night ( ☾ ) and anti-freeze ( ❄ ) temperatures

The **AURATON 2025 / AURATON 2025 RTH** regulator allows for programming 3 kinds of temperatures:

- Day temperature ( ☀ ) - from 5 to 30 °C
- Night temperature ( ☾ ) - from 5 to 30 °C
- Antifreeze temperature ( ❄ ) - from 4 to 10 °C

In order to set one of the above temperatures:

1. Press the **TEMP** button.

2. The current temperature setpoint will appear on the display with the symbol:

- ☀ – day temperature,
- ☾ – night temperature,
- ❄ – anti-freeze temperature.

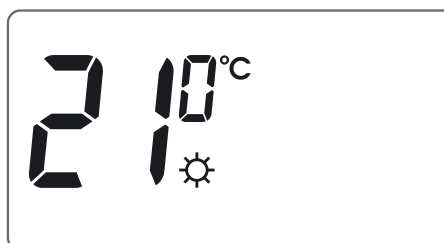

3. Using the **▼** and **▲** buttons, set the desired temperature setpoint.

4. By pressing the **TEMP** button, toggle between the available kinds of temperature to be set ( ☀ , ☾ , ❄ );

5. After setting all 3 temperature setpoints, confirm the setting with the **OK** button.

**NOTE:** The value of the night temperature setpoint can be equal to or lower than the value of the day temperature setpoint. It is not possible to set the night temperature setpoint higher than the day temperature setpoint.

# INTRODUCTION TO PROGRAMMING

## Time line

The LCD display displays the time line divided into 24 sections, where each section corresponds to 1 hour of a 24-hour long day.

A black rectangle above a given hour indicates that the day temperature is maintained, whereas no such a rectangle indicates that the night temperature is maintained.

*An example:*



*The above picture shows that from 06:00 to 23:00 the regulator controls the heating device in a manner to maintain the day temperature in the room ( ☀ ). From 23:00 to 06:00 the regulator switches over to the night temperature ( ☾ ).*

## Factory programs

In order to let the regulator know when to use the day or the night temperature, it is necessary to assign an appropriate program to each day of week. In order to do this, you can use one of the three factory-defined programs:

### **Program no. 0 – anti-freezing** ❄️

A factory program designed for setting the anti-freezing temperature. Selecting this program causes the maintaining of the anti-freezing temperature throughout the day.

### **Program no. 1 – week days**

A factory program that cannot be modified. Setting this program causes the heating devices to maintain the day temperature from 05:00 to 0800 and from 15:00 to 23:00.

### **Program no. 2 – weekend**

A factory program that cannot be modified. Setting this program causes the heating device to maintain the day temperature from 06:00 to 23:00.

### **Program no. 3, 4, ..., 9 – user defined**

Programs no. 3 through 9 are user-defined programs. The user can modify and adapt them at will.

## PROGRAMMING

### Weekly programming

In order to program the regulator, it is necessary to decide on which day of the week and during what period of time the day temperature should be maintained. During the remaining time, the night temperature will be maintained.

*An exemplary mode of operation of the regulator from Monday until Sunday. Besides the defined periods of time, the regulator maintains the lower night temperature.*

Day of week	Day temperature
Monday	6:00–8:00; 15:00–23:00
Tuesday	6:00–8:00; 15:00–23:00
Wednesday	6:00–8:00; 15:00–23:00
Thursday	6:00–8:00; 15:00–23:00
Friday	6:00–8:00; 15:00–23:00
Saturday	8:00–23:00
Sunday	8:00–23:00

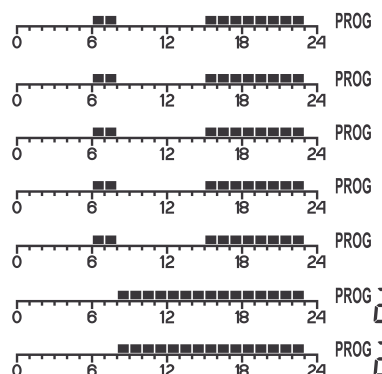

### SELECTING A PROGRAM

In order to select a program:

1. Press the **PROG** button. The program description field starts flashing.
2. Press the **D** button. Using the **▼** and **▲** buttons or the **D** button set the day of the week when the program should be executed.
3. Pressing the **PROG** button several times, select the desired program number. Programs no. 0-2 are factory-defined and programs no. 3-9 can be modified.
4. Confirm the setting with the **OK** button.
5. Return to step 1 and repeat the above procedure for the next day of the week. Programming can end when each day of week is assigned an appropriate program.

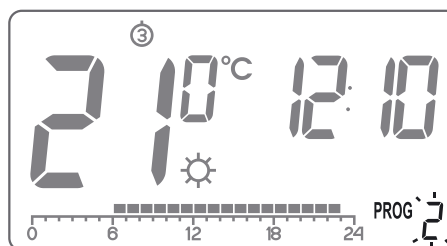
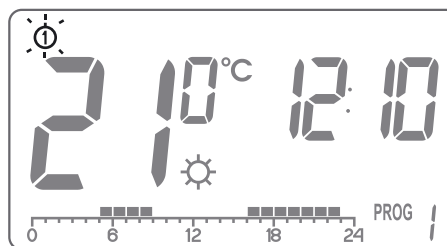
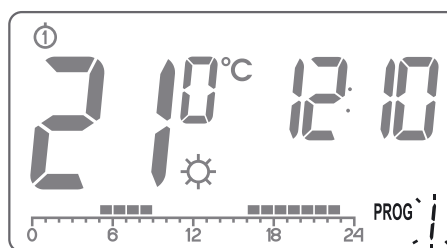



## MODIFYING A USER-DEFINED PROGRAM (prog. 3...9)

In order to modify a program:

1. Press the **PROG** button. The program description field starts flashing.
2. Press the **D** button. Using the **▼** and **▲** buttons or the **D** button, set the day of the week when the program should be executed.
3. Pressing the **PROG** button several times, select programs number 3-9 (user-defined)

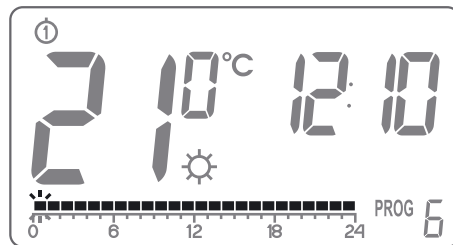
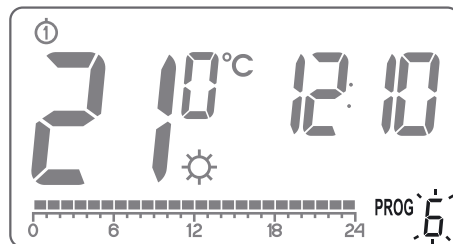
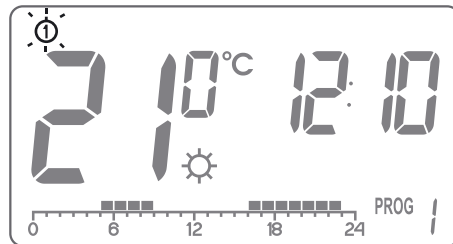
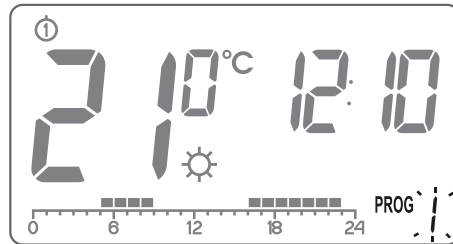





4. All (24) rectangles will be lit on the time line. One rectangle corresponds to one hour. If a rectangle is visible, the day temperature will be maintained during the corresponding hour. A turned off rectangle indicates that the night temperature will be maintained. In the picture, the first rectangle flashes - a flashing rectangle indicates the point on the time line where the change is being made.

5. Pressing the **☀** or **☾** button, select the day temperature (visible rectangle) or the night temperature (turned off rectangle).
6. Using the **▼** and **▲** buttons, highlight consecutive hours on the time line, and for each hour select the day or night temperature (a currently selected rectangle is turned on or off with the **☀** or **☾** button, respectively).
7. Having modified the entire time line, save the program with the **OK** button.



**NOTE:** Once modified, the program can be assigned to other days of the week by selecting it for that day.

## Manual control

When, for any reason, you would like to suspend execution of the program for a certain period of time, e.g. due to a party when you want to maintain the day temperature until the end of the party, and the regulator has already started decreasing the temperature down to the night temperature setpoint (“ ” is displayed), perform the following steps:

1. Press the  button. The “ ” will appear on the display. A comfortable temperature will be maintained until the next temperature change performed by the program.
2. **In order to cancel** the above mentioned function, press the  button located under the battery cover; the “ ” symbol will disappear.









Similarly, if the program at the moment maintains the day temperature and you leave your home for a longer period of time, then:

1. Press the  button. The “ ” will appear on the display. The night temperature will be maintained until the next temperature change performed by the program.
2. **In order to cancel** the above mentioned function, press the  button.

## Vacation mode

There are times when we leave our homes for a longer time. In order to avoid re-programming the entire regulator, vacation mode can be used. This mode makes the regulator to maintain just one temperature during the entire period of your absence. It can last for as short as 1 hour, and as long as 99 days.

In order to enter vacation mode:

1. Press the  or  button and hold it for 3 seconds. The display shows the temperature and the flashing time field. Use this field to set the duration for the vacation mode.
2. Using the  and  buttons, set time: hours (1-23) and then days (1-99). Confirm the setting with the  button.
3. The temperature field starts flashing. Using the  and  buttons, set the temperature. Confirm the setting with the  button.



If the selection is not confirmed within 10 seconds, the regulator will automatically enter vacation mode.

In order to leave vacation mode, press the  button.

**NOTE:** The vacation temperature is independent of the day, night or anti-freezing temperature.

## Setting the anti-freezing temperature program



The **AURATON 2025 / 2025 RTH** regulator is equipped with a setpoint for the anti-freeze temperature. This setpoint can be set within the range from 4 to 10 °C. (Factory set at 7 °C)

The anti-freezing temperature setpoint is used during a prolonged absence or outside the heating season and is designed to prevent water in the heating system from freezing. In order to set the anti-freezing temperature program, select the **program no. 0** for each day of week.

(See chapter: "Weekly programming - selecting a program")

## Heating device run time counter

The **AURATON 2025 / 2025 RTH** regulator is equipped with a function for counting the run time of the heating device. The function is activated by pressing the  button and holding it for 5 seconds.

The display will show information about the accumulated run time since the last reset of the device.

**NOTE:** The run time counter counts the time between sending the "switch on the heating device" signal (displaying the "fan" symbol) and sending the "switch off the heating device" signal. This time can vary from the actual run time of the heating device, e.g. due to the fact of using internal thermostats in heating devices.

## Replacing batteries

"Low battery" (  ) indicator appears on the LCD if voltage reached its minimum level. Replace batteries as soon as possible.

**NOTE:** *To maintain programmed parameters replace batteries within 30 seconds.*



## Cooperation of the RTH receiver with a heating device

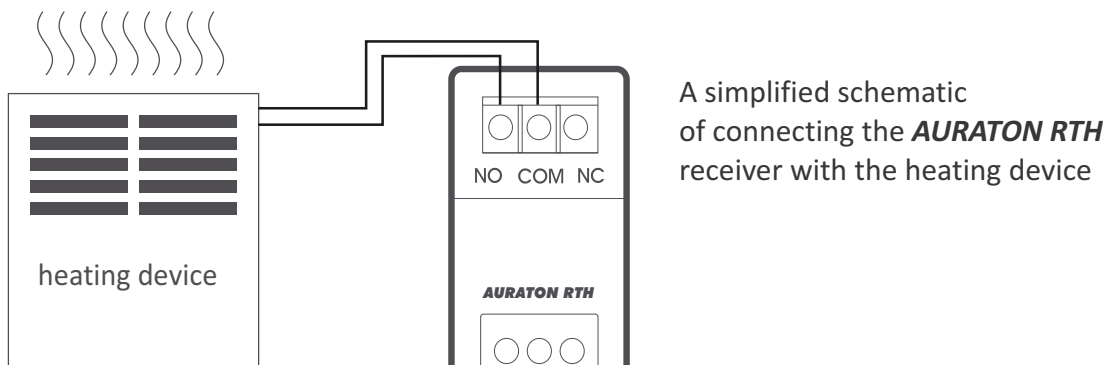
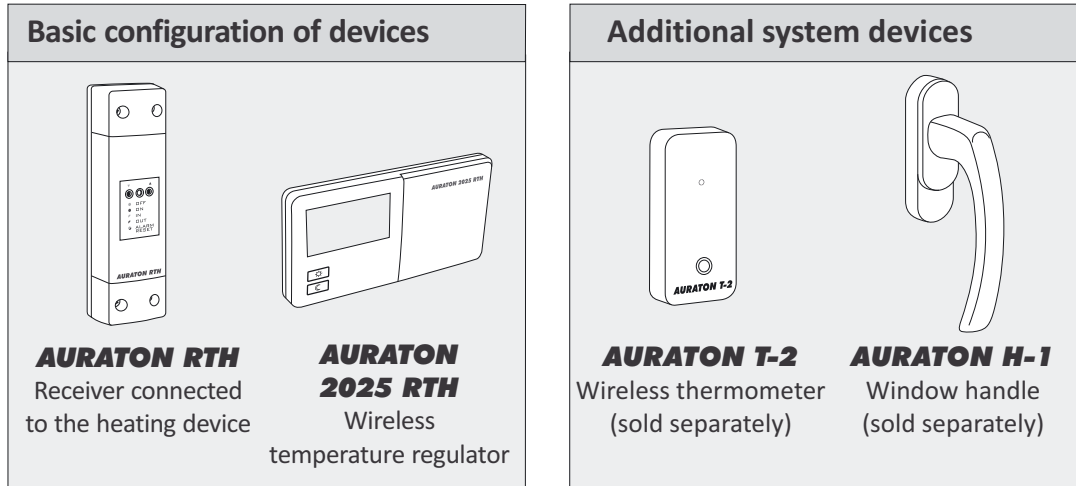

### Cooperation of the AURATON RTH receiver with the AURATON 2025 RTH regulator and/or the AURATON T-2 thermometer

The operation of temperature regulation in the receiver is based on the binary algorithm (on/off) using one or two sensor elements.

- The **AURATON 2025 RTH** regulator allows for setting and/or monitoring the temperature.
- The **AURATON T-2** thermometer provides information about the current temperature only, without the capability of changing it manually.

**A) The manual setpoint** – pairing the **AURATON 2025 RTH** regulator with the **RTH** receiver allows for setting the temperature manually and controlling it in the location of the fastening of the **2025 RTH** regulator.

- B) The remote setpoint** – if the **T-2** thermometer is additionally paired with the **RTH** receiver, the **AURATON 2025 RTH** regulator retains the capability of temperature setting, however its control is performed with the paired **T-2** thermometer only. This feature allows for regulating the temperature in a room other than the one where the **AURATON 2025 RTH** regulator is placed.

*An example: you want the temperature in the “children’s room” to be always at 22 °C, however you do not want children to be able to change it - in that room, you install the **T-2** thermometer, and the **AURATON 2025 RTH** regulator in e.g. the kitchen. This way the temperature in the “children’s room” will always be at 22 °C regardless of temperature fluctuations in the kitchen.*

- C) The factory setpoint (20 °C)** – if the **T-2** thermometer is the only device paired with the **RTH** receiver, it is not possible to set the temperature manually, and the **RTH** receiver maintains the factory temperature setpoint of 20 °C.

**NOTE!**

1. The sequence of pairing the **AURATON 2025 RTH** regulator and the **T-2** thermometer is very important. If you want to maintain the remote setpoint, you must first pair the **AURATON 2025 RTH** with the **RTH** receiver, and then the **T-2** thermometer. Reversing the pairing sequence will cause automatic deregistering of the previously paired **T-2** thermometer and entering the mode of operation described in item A.
2. The **RTH** receiver can operate with one **AURATON 2025 RTH** regulator and/or one **T-2** thermometer only. Pairing a new regulator causes deregistering the previously paired regulator and the **T-2** thermometer. Pairing a new **T-2** thermometer causes deregistering the previously paired **T-2** thermometer only.
3. The **2025 RTH** regulator and/or the **T-2** thermometer can operate with an unlimited number of receivers, e.g. one regulator can simultaneously control two independent heating devices.

## Cooperation with the AURATON 2025 RTH regulator and/or the AURATON T-2 thermometer as well as the AURATON H-1 handles

By default, the **AURATON RTH** receiver does not have any **AURATON H-1** handle or AURATON W-1 window position sensor paired, therefore the relay is controlled by the paired **AURATON 2025 RTH** regulator and/or the **AURATON T-2** thermometer. When at least one **H-1** handle is paired with the **RTH** receiver, the relay is controlled in the following manner:

### A) The window is closed or trickle-ventilated (micro-ventilation).

When the **H-1** window handles is paired with the receiver, and all windows are closed or trickle-ventilated, the relay still maintains the setpoint from the paired **AURATON 2025 RTH** regulator and/or the **T-2** thermometer.

### B) The window is pivoted.

If at least one window is pivoted, the temperature set in the **AURATON 2025 RTH** regulator is lowered in **AURATON RTH** receiver down to 3 °C. This state will be maintained until closing. This state will last until all windows are closed or trickle-ventilated.

### C) The window is opened.

When you open a window equipped with the **H-1** handle paired for longer than 30 seconds, the relay in the **AURATON RTH** receiver is switched off, as is the connected heating device. If all the assigned windows are again in a state other than “opened”, the **RTH** receiver returns to normal cooperation with the **AURATON 2025 RTH** regulator and/or the **T-2** thermometer no earlier than 90 seconds after switching off the relay. The purpose of this delay is to prevent too rapid transitions of the connected heating devices between the ON and OFF states. However, if the temperature in the room drops below 7 °C, the relay inside the receiver is switched on regardless of the positions of windows in order to prevent the room from freezing.

### D) The signal is lost.

When the **RTH** receiver has lost the signal from the **H-1** handle paired (3 consecutive transmissions are lost), it changes the status of this window to “closed”. When the transmission is restored, the **H-1** handle is again properly read off by the **RTH** receiver.

## RESET of the regulator

Pressing the **RESET button** (  ) causes the time and day setting to be erased, and the regulator to be restarted.

## MASTER RESET of the regulator

The MASTER RESET function restarts the regulator and restores factory settings. This function is invoked by pressing the  and **RESET buttons** simultaneously.

**NOTE: All user-defined programs will be erased!**

## Special situations

- When 3 consecutive transmissions (after 15 minutes) from the **AURATON 2025 RTH** regulator and/or the **T-2** thermometer are lost, an error is signalled on the **RTH** receiver (LED flashing continuously red and green). The **RTH** receiver starts executing the ON - OFF cycle memorised during the last 24 hours of operation until the problem is removed.
- When both signals return (from the **AURATON 2025 RTH** regulator and the **T-2** thermometer), the error is cancelled and the receiver enters its normal mode of operation.
- When only the **T-2** thermometer signal returns, the receiver uses the last memorised setpoint value and maintains it while signalling the error.
- When the **H-1** handles, the **T-2** thermometer and the **AURATON 2025 RTH** regulator (the temperature is measured with the **T-2** thermometer) are paired with the receiver, then maintaining the work cycle from the last 24 hours occurs only after losing the signal from the **T-2** thermometer. When only the signal from the **AURATON 2025 RTH** is missing, the RTH receiver automatically maintains the last memorised setpoint from the **AURATON 2025 RTH** regulator and also signals an error.
- When you have only the **H-1** handles and the **T-2** thermometer paired with the **RTH** receiver without the **AURATON 2025 RTH** regulator, the **RTH** receiver maintains a constant, factory-defined temperature of 20 °C. If you pivot any window equipped with the **H-1** handle paired with the receiver, a temperature of 17 °C is maintained. If you open any window equipped with the **H-1** handle paired with the **RTH** receiver, the receiver switches off the heating device, but will switch it back on when the temperature falls below 7 °C.

## Unique features of AURATON 2025 RTH

- Switching the relay is synchronised with the wave of the 230 V mains voltage in order to ensure that closing and opening contacts of the relay occurs around the zero-crossing point. This prevents the occurrence of an electric arc, significantly extending the relay service time.
- The **AURATON RTH** receiver is equipped with a unique algorithm for analysing the ON - OFF cycles. The entire heating cycle from the last 24 hours is recorded in the memory of the **RTH** receiver. In the event of losing communication with the **AURATON 2025 RTH** regulator and/or the **T-2** thermometer, the **RTH** receiver automatically executes the ON - OFF cycle memorised during the last 24 hours. This provides time for restoring transmission (removing interferences) or fixing the **2025 RTH** regulator and/or the **T-2** thermometer without a significant deterioration of thermal comfort conditions in the controlled spaces.
- The backlit LCD display with the capability of selecting one of three available colours.
- The run time counter of the **AURATON 2025 RTH** transmitter.
- Cooperation with optional devices (the **AURATON T-2** thermometer, the **AURATON H-1** window handle).

## Additional information and notes



- The **AURATON 2025 RTH** regulator and/or the **T-2** thermometer must be installed at least 1 metre from the **RTH** receiver (too strong a signal from the transmitters can cause interference).
- At least 30 seconds must elapse between switching the relay off and on.
- Data transmission from the **AURATON 2025 RTH** regulator to the receiver occurs upon each change of 0.2 °C of the surrounding temperature. When the temperature is stable, the regulator sends heart-beat data every 5 minutes (which is signalled with the LED blinking orange on the **RTH** receiver).
- In the event of a power outage, the **RTH** receiver will switch off. When power is restored, the heating device is switched on automatically, and the **RTH** receiver awaits a signal from the paired transmitters (this signal should be received within 5 minutes of restoring power). After receiving the signal, the **RTH** receiver enters the normal mode of operation.
- The **RTH** receiver cannot be placed in metal containers (e.g. an assembly box, a metal enclosure of a heater) in order to not to interfere with its operation.





## Configuration settings: backlight colour, hysteresis, delay, offset

Configuration settings are presented for changing in the following order:



To enter the configuration settings change mode press the,   buttons simultaneously and hold them for 5 seconds until the display backlight starts flashing.

### 1. BACKLIGHT COLOUR CHANGE:

Flashing backlight indicates that you can change the backlight colour with the   buttons.

Confirm the setting by pressing the  button.

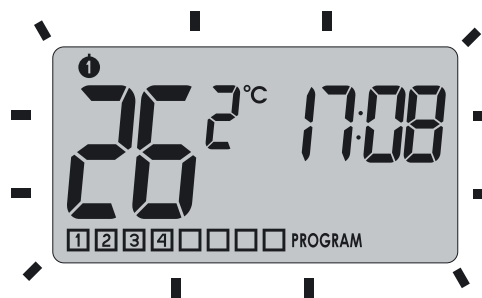

The regulator will proceed to change the next parameter.



### 2. HYSTERESIS CHANGE:

Hysteresis is designed to prevent switching the controlled device on and off too frequently due to minute fluctuations of temperature.

*E.g. for the HI 2 hysteresis, when the temperature is set to 20°C, the boiler will be switched on at 19.8°C, and switched off at 20.2°C. For the HI 4 hysteresis, when the temperature is set to 20°C, the boiler will be switched on at 19.6°C, and switched off at 20.4°C.*

The hysteresis change mode is signalled by flashing text “HI”. You can change hysteresis settings with the   buttons.

**HI 2** –  $\pm 0,2^{\circ}\text{C}$  (factory setting)

**HI 4** –  $\pm 0,4^{\circ}\text{C}$



Confirm the setting by pressing the  button.

The regulator will proceed to change the next parameter.



### 3. DELAY CHANGE (AURATON 2025 only)

Delay is designed to prevent switching the controlled device on and off too frequently e.g. due to a momentary whiff of air caused by opening a window.

This mode is signalled by flashing text "90:SE". You can switch the delay on and off with the   buttons.

**90:SE** – 90s delay  
(factory setting)

**0:SE** – without delay





Confirm the setting by pressing the  button. The regulator will proceed to change the next parameter.

### 4. OFFSET CHANGE

Offset allows for calibrating temperature indications within the tolerance of  $\pm 3^{\circ}\text{C}$ .

*E.g. the temperature regulator indicates that the room temperature is 23 °C, whereas a regular mercurial thermometer placed alongside indicates 24 °C. Changing offset by +1 degree makes the regulator indicate the same temperature as the mercurial one.*

The offset change mode is signalled by flashing text **OFFS**.

You can set the desired value (   ) within the range from 3.0 to 3.0 (factory setting is 0.0).

Confirm the setting by pressing the  button. The regulator will resume normal mode of operation.



**NOTE:** If no button is pressed for 10 s while changing configuration settings, the regulator will resume normal mode of operation.

## The AURATON 2025 regulator connection schematics

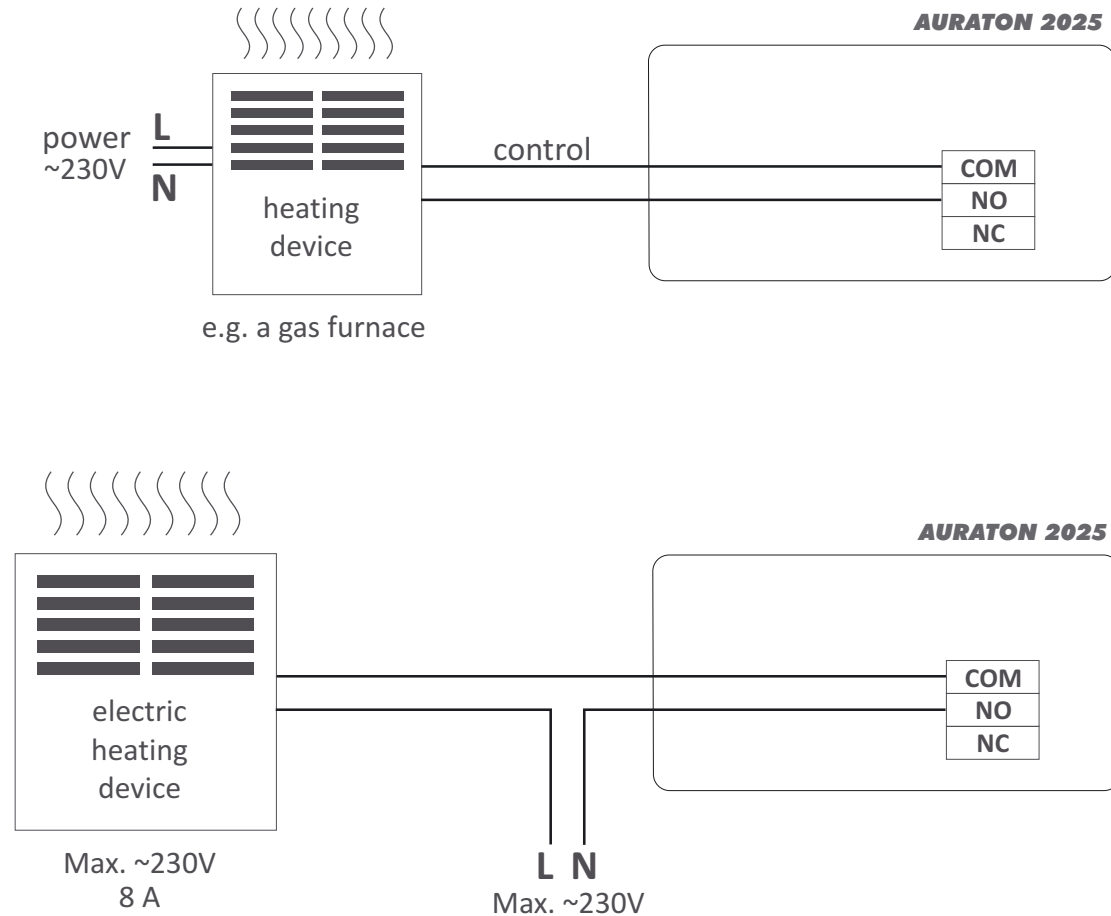

### WARNING !

Cables supplied with the regulator are designed for conducting maximal load of 2.5 A.



If devices to be connected require more power, the cables need to be replaced with cables of the appropriate cross-sectional area.

## The AURATON RTH receiver connection schematics

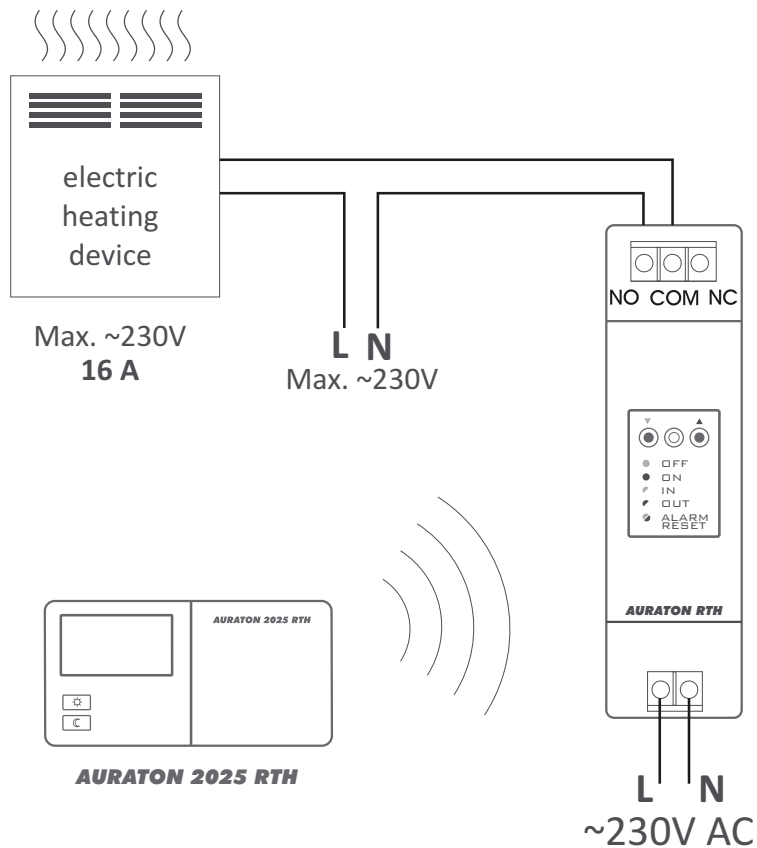
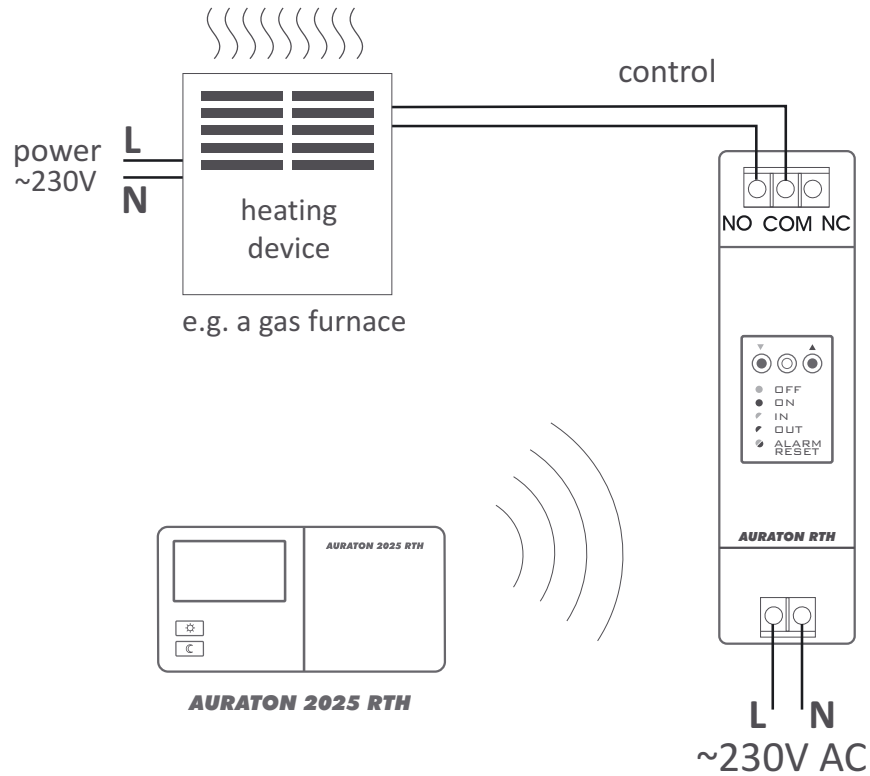

## Technical specifications

Working temperature range:	0 – 45°C
Temperature measurement range:	5 – 30°C
Span:	±0,2°C
Temperature levels:	3 + vacation
Antifreeze temperature:	4 – 10°C
Working cycles:	weekly, programmable
Working mode control:	LED (the RTH receiver) / LCD (the regulator)
Maximum load:	<i>AURATON 2025</i> ~ 8A 250V AC (inductive 5A) <i>AURATON RTH</i> ~ 16A 250V AC
Power supply: <b><i>AURATON 2025</i></b> <b><i>AURATON 2025 RTH</i></b>	2x AA alkaline battery
<b><i>RTH</i></b> power supply:	230V AC, 50Hz
<b><i>RTH</i></b> radio frequency:	868MHz
<b><i>RTH</i></b> Operation range:	in a typical building, with standard construction of walls - approx. 30 m an open space - up to 300 m

## Disposing of the devices



The devices are marked with the crossed waste bin symbol. According to European Directive no. 2002/96/EU and the Act concerning used up electric and electronic equipment, such a marking indicates that this equipment may not be placed with other household generated waste.

**The user is responsible for delivering the devices to a reception point for used-up electric and electronic equipment.**

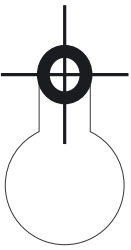

A template for drilling holes for fastening the AURATON 2025  
and AURATON 2025 RTH regulator  
(1:1 scale)

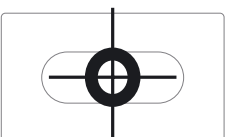

A template for drilling holes for fastening  
the AURATON RTH receiver (1:1 scale)

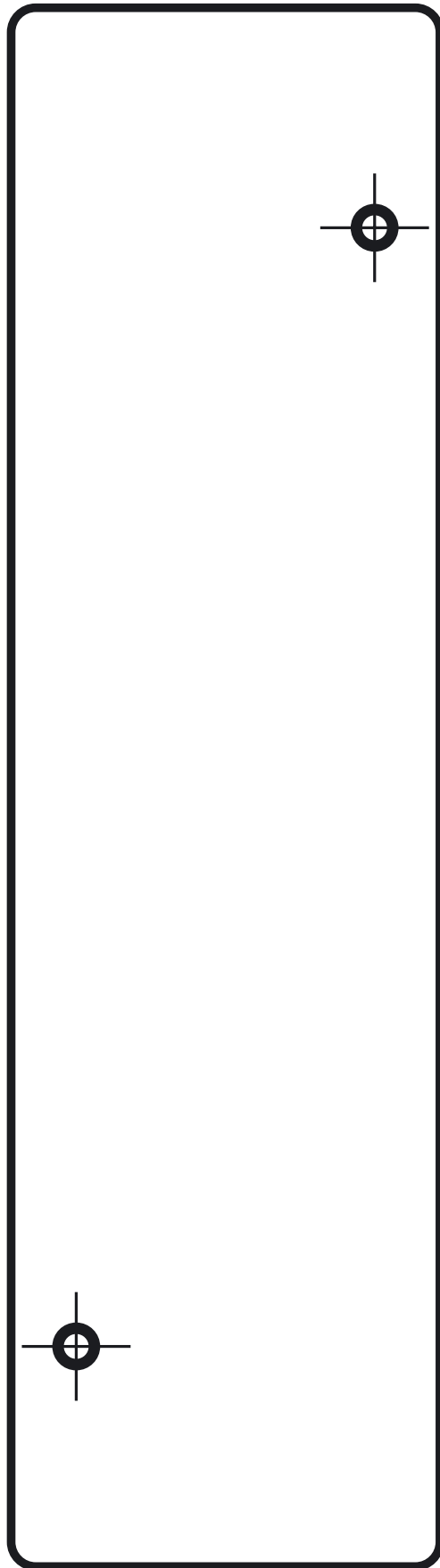

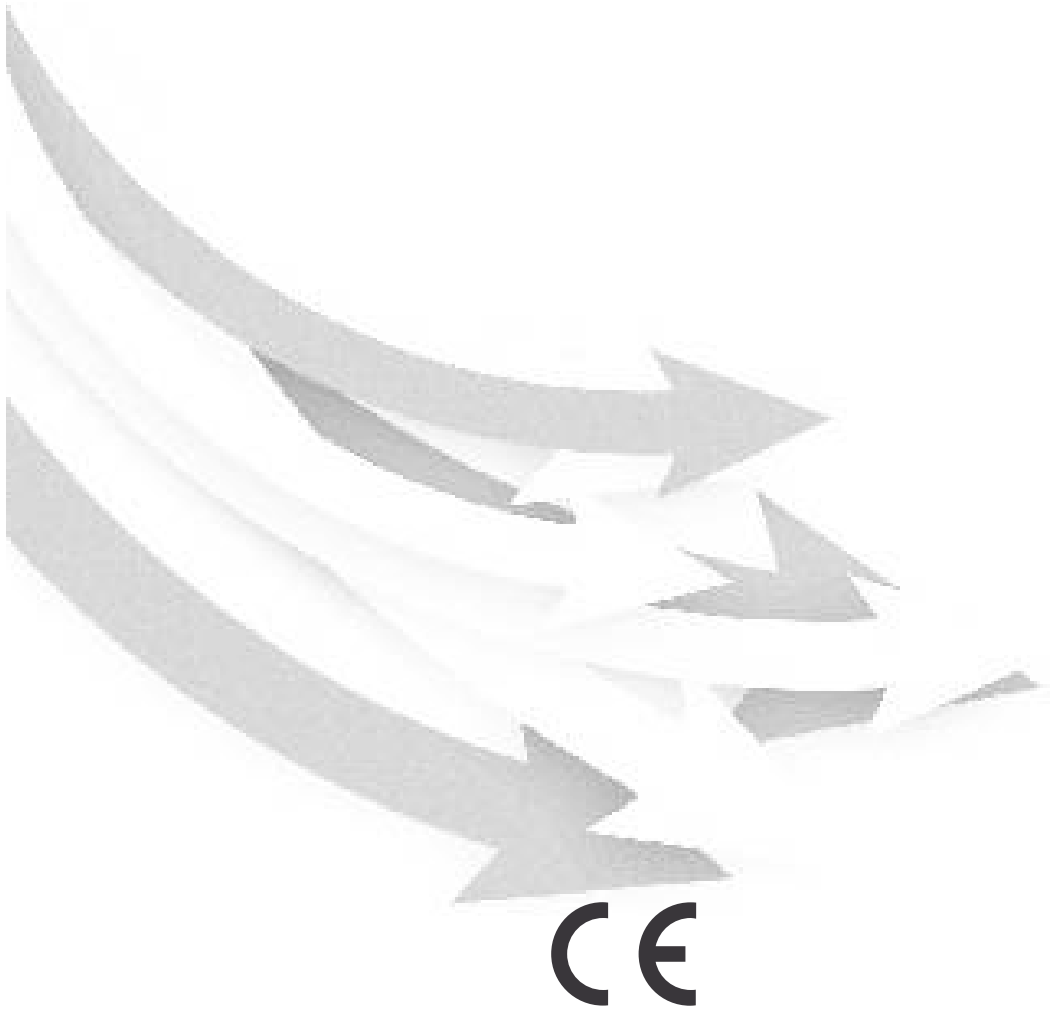

[www.auraton.pl](http://www.auraton.pl)